

---

# TFT-LCD Module Specification

**Module NO.:** TST144014CPIL-04B

**Version:** V1.0

APPROVAL FOR SPECIFICATION

APPROVAL FOR SAMPLE

For Customer' s Acceptance:	
Approved by	Comment

Team Source Display:		
Presented by	Reviewed by	Organized by

Version No.	Date	Content	Remark
V1.0	2017-03-2	Initial Release	

**CONTENTS**

**1 GENERAL CHARACTERISTICS..... - 3 -**

**2 PRODUCT DRAWINGS..... - 4 -**

**3 INTERFACE DESCRIPTION..... - 5 -**

**4 LCM INTERFACE TIMING..... - 5 -**

    4.1 RESET TIMING..... - 5 -

    4.2 MCU READ/WRITE TIMING..... - 6 -

**5 ABSOLUTE MAXIMUM RATINGS..... - 7 -**

**6 ELECTRICAL CHARACTERISTICS..... - 7 -**

**7 BACKLIGHT CHARACTERISTICS..... - 7 -**

**8 LCD OPTICAL SPECIFICATIONS..... - 8 -**

**9 RELIABILITY TEST..... - 9 -**

**10 INSPECTION STANDARDS..... - 10 -**

    10.1 VISUAL INSPECTION CRITERION IN COSMETIC..... - 10 -

        10.1.1 Glass defect..... - 10 -

        10.1.2 LCM appearance defect..... - 10 -

        10.1.3 FPC..... - 11 -

        10.1.4 Black tape..... - 11 -

        10.1.5 Silicon..... - 11 -

        10.1.6 Touch Panel..... - 11 -

    10.2 VISUAL INSPECTION CRITERION IN ELECTRICAL DISPLAY..... - 12 -

    10.3 OTHERS..... - 12 -

**11 SUGGESTIONS FOR USING LCD MODULES..... - 12 -**

    11.1 HANDLING OF LCM..... - 12 -

    11.2 STORAGE..... - 13 -

## 1 General Characteristics

ITEM	Specification	Unit
LCD Type	a-Si TFT, Transmissive, Normally white, TN	-
LCD Size	1.44	inch
Resolution (W x H)	128x (RGB) × 128	pixel
LCM (W × H × D )	38.5(W) x 39.4(H) x 3.0(D)	mm
Active Area (W × H)	25.5 (W) x 26.5 (H)	mm
Dot Pitch (W × H)	0.1992 x 0.207	mm
Viewing Direction	12 o'clock	-
Gray Scale Inversion Direction	6 o'clock	-
Viewing Angle	Top:20, Bottom:35; Left/ Right:45	deg.
Color Depth	65K/262K	-
Pixel Arrangement	RGB Vertical stripe	-
Backlight Type	2 LEDs, 20mA	-
Surface Luminance	280 ± 30	cd/m <sup>2</sup>
Surface Treatment	Anti-Glare	-
Driver IC	ILI9163	-
Interface Type	MCU 8-bit	-
Input Voltage	2.8 (Typ)	V
With/Without TP	without	-
Weight	TBD.	g

**Note 1: RoHS compliant**

**Note 2: LCM weight tolerance: ± 5%.**



### 3 Interface description

PIN NO.	Symbol	description
1	LEDA	Backlight A Aothod input pin.
2	LEDK	Backlight K Cathode input pin.
3	GND	System Ground. (0V)
4	VCC	Power supply +2.8V
5	NC	
6	NC	
7	CS	Chip select signal.
8	RS	Data/Command Selection pin
9	WR	write signal input pin
10	RD	read signal input pin
11~18	NC	
19~26	DB0~DB7	Data BUS
27	RESET	Reset input signal
28	NC	
29	NC	
30	GND	System Ground. (0V)

### 4 LCM Interface Timing

#### 4.1 Reset Timing

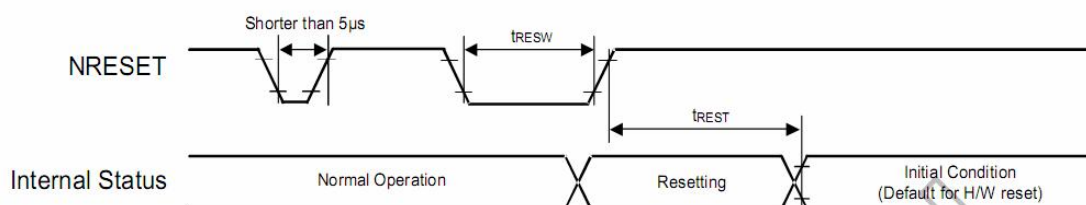

Signal	Symbol	Parameter	Min	Max	Unit
NRESET	tRESW	Reset low pulse width	10	-	us
	tREST	Reset complete time	5 (note 1)	-	ms
			120(note 2)	-	ms

Note: (1) When reset applied during SLPIN mode;  
 (2) When reset applied during SLPOUT mode.

### 4.2 MCU Read/Write Timing

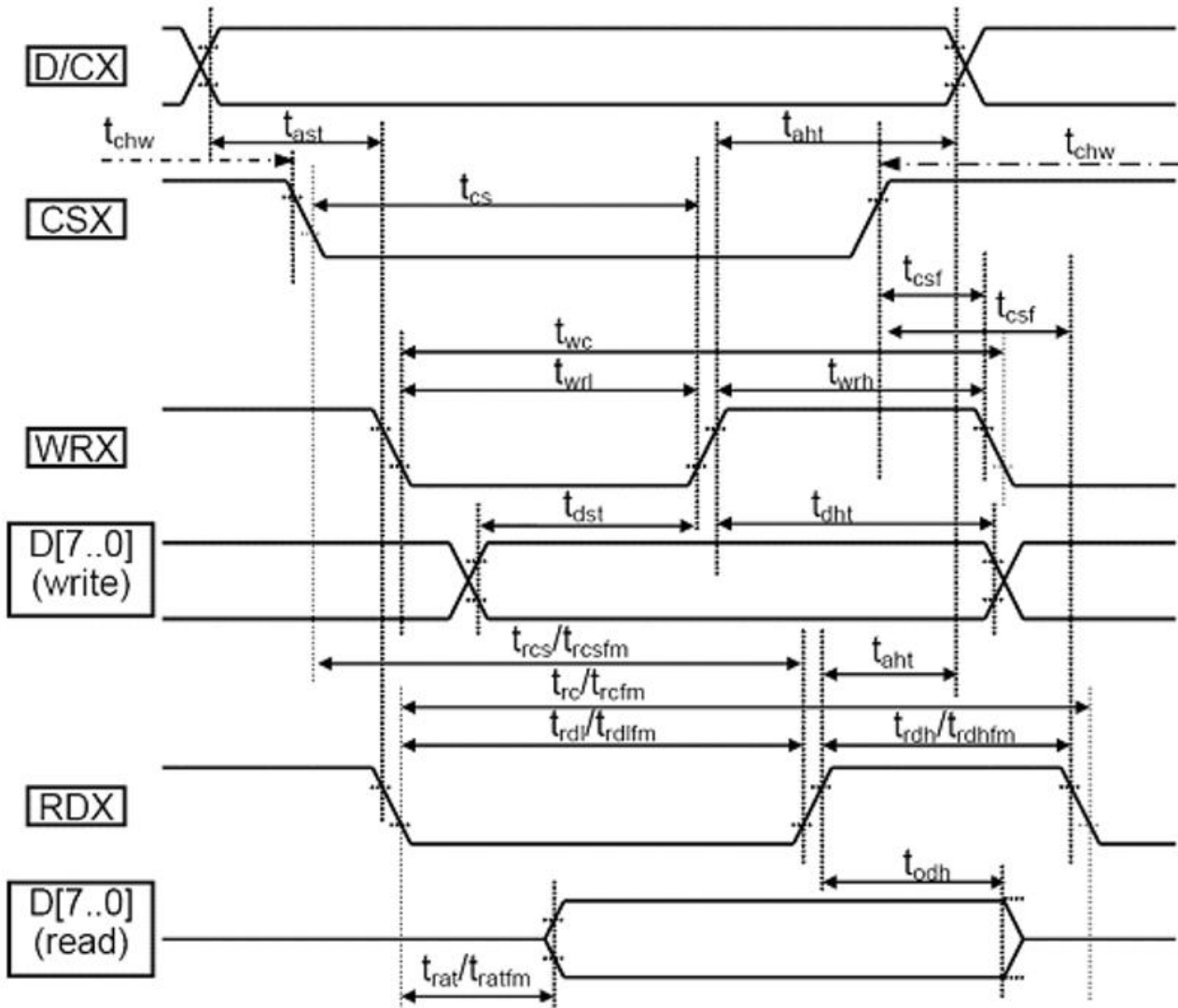

Note: Logic high and low levels are specified as 30% and 70% of VDDI for Input signals.

Signal	Symbol	Parameter	Min.	Max.	Unit	Description
DCX	tAST	Address setup time	0	-	ns	-
	tAHT	Address hold time (Write/Read)	10	-		
CSX	tCS	Chip select setup time (Write)	15	-	ns	-
	tRCS	Chip select setup time (Read register)	45	-		
	tRCSFM	Chip select setup time (GRAM)	355	-		
	tCSF	Chip select wait time (Write/Read)	10	-		
WRX	tWC	Write cycle (write register)	66	-	ns	-
	tWRH	Control pulse "H" duration	15	-		
	tWRL	Control pulse "L" duration	15	-		
RDX	tRC	Read cycle (read register)	160	-	ns	-

	tRC	Read cycle (GRAM)	450	-		
	tRDH	Control pulse "H" duration	90	-		
	tRDL	Control pulse "L" duration(read register)	45	-		
	tRDL	Control pulse "L" duration(GRAM)	355	-		
DB[7:0]	tDST	Data setup time	10	-	ns	For maximum CL=30pF For minimum CL=8pF
	tDHT	Data hold time	10	-		
	tRAT	Read access time(read register)	-	40		
	tRAT	Read access time(GRAM)	-	340		
	tODH	Output disable time	20	80		

Note 1: VDDI 1.65 to 3.3V, VCI=2.6 to 3.3V, AGND=GND=0V, Ta=-30 to 70 ° C (to +85° C no damage)

Note 2: This input signal rise time and fall time (tr, tf) is specified at 15 ns or less. Logic high and low levels are specified as 30% and 70% of VDDI for input signals

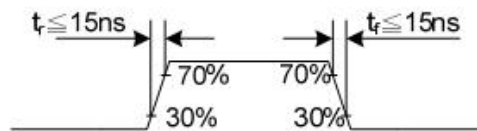

## 5 Absolute Maximum Ratings

PARAMETER	SYMBOL	MIN	MAX	UNIT
Supply Voltage (Analog)	VCC~GND	-0.3	4.0	V
Logic signal voltage(I/O)	IOVCC~GND	-0.3	3.3	V
Operating Temperature	TOP	-20	70	° C
Storage Temperature	TST	-30	80	° C
Humidity	RH	-	90%(Max 60° C)	RH

## 6 Electrical Characteristics

PARAMETER	SYMBOL	MIN	TYP	MAX	UNIT
Analog operating voltage	VCC	2.5	2.8	4.0	V
Logic operating voltage	IOVCC	1.65	1.8	3.3	V
Input Current	IDD	-	TBD	-	mA
Input Voltage 'H' level	VIH	0.7IOVCC	-	IOVCC	V
Input Voltage 'L' level	VIL	GND	-	0.3IOVCC	
Output Voltage 'H' level	VOH	0.8IOVCC	-	IOVCC	
Output Voltage 'L' level	VOL	GND	-	0.2IOVCC	

## 7 Backlight Characteristics

ITEM	SYMBOL	MIN	TYP	MAX	UNIT
Voltage for LED backlight	Vf	-	6.2	6.4	V
Current for LED backlight	If	-	15	20	mA
Power consumption	Wbl	-	93	128	mW
Uniformity	Avg	80	-	-	%
LED Life Time	-	30000	40000	-	Hrs

Note:

1. The LED life time is defined as the module brightness decrease to 50% original brightness at Ta=25°C, 60%RH ±5 %.
2. The life time of LED will be reduced if LED is driven by high current, high ambient temperature and humidity conditions.
3. Typical operating life time is an estimated data.
4. Permanent damage to the device may occur if maximum values are exceeded or reverse voltage is loaded .Functional operation should be restricted to the conditions described under normal operating conditions.

## 8 LCD Optical specifications

Item	Symbol	Condition	Specification			Unit	Remark
			Min.	Typ.	Max.		
Response time (By Quick)	Tr+Tf	$\theta = 0^\circ$	-	25	-	ms	Note 4
Contrast ratio	CR	$\theta = 0^\circ$	-	350	-		Note 3
Viewing angle	Top	$CR \geq 10$	-	20	-	Deg.	Note 5
	Bottom	$CR \geq 10$	-	35	-		
	Left	$CR \geq 10$	-	45	-		
	Right	$CR \geq 10$	-	45	-		
Color chromaticity (CF only with ITO, light source is C light, CIE 1931)	Wx	$\theta = 0^\circ$	0.285	0.305	0.325		Note 6
	Wy		0.314	0.334	0.354		
	Rx		0.588	0.608	0.628		
	Ry		0.296	0.316	0.336		
	Gx		0.285	0.305	0.325		
	Gy		0.536	0.556	0.576		
	Bx		0.115	0.135	0.155		
	By		0.117	0.137	0.157		
NTSC			53%				
Transmittance (with Polarizer)	T(%)	$\theta = 0^\circ$	-	6.0	-	%	

Note 1. Ambient condition: 25°C ± 2°C, 60 ± 10%RH, under 10 Lux in the darkroom.

Note 2. Measure device: BM-5A (TOPCON), viewing cone= 1 ° , IL=20mA.

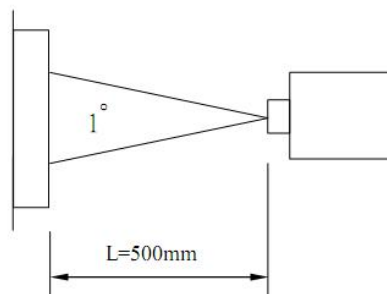

Note 3. Definition of Contrast Ratio:

$$CR = \text{White Luminance (ON)} / \text{Black Luminance (OFF)}$$

Note 4. Definition of response time: The response time is defined as the time interval



between the 10% and 90% amplitudes.

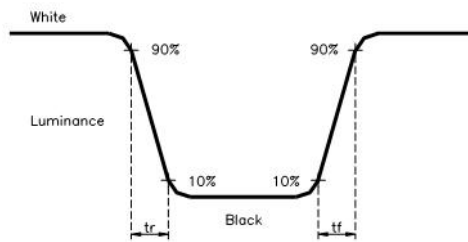

Note 5. Definition of view angle(  $\theta$  ,  $\phi$  ):

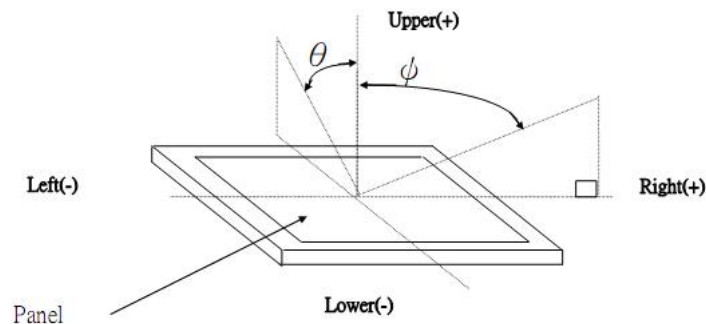

Note 6. Light source: C light.

## 9 RELIABILITY TEST

NO.	TEST ITEM	TEST CONDITION	INSPECTION AFTER TEST
1	High Temperature Storage	80±2°C/96 hours	Inspection after 2~4 hours storage at room temperature and humidity. The condensation is not accepted. The sample shall be free from defects:  1. Air bubble in the LCD 2. Seal leak 3. Non-display 4. Missing segments 5. Glass crack
2	Low Temperature Storage	-30±2°C/96 hours	
3	High Temperature Operating	70±2°C/96 hours	
4	Low Temperature Operating	-20±2°C/96 hours	
5	Temperature Cycle	-30±2°C ~ 25~ 80± 2°C × 10 cycles (30 min.) (5min.) (30min.)	
6	Damp Proof Test	60°C ±5°C × 90%RH/96 hours	
7	Vibration Test	Frequency 10Hz~55Hz Stroke: 1.5mm Sweep: 10Hz~150 Hz~10Hz 2 hours For each direction of X, Y, Z	
8	Shock Test	Half-sine, wave, 300m/s	
9	Packing Drop Test	Height: 80 cm 1 corner, concrete floor	
10	Electrostatic Discharge Test	C=150pF, R=330 Ω Air: ±8KV 150pF/330Ω 30 times Contact: ±4KV,20 times	

## 10 Inspection standards

### 10.1 Visual inspection criterion in cosmetic

#### 10.1.1 Glass defect

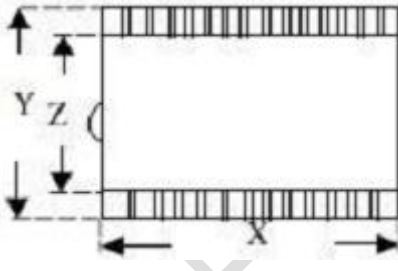
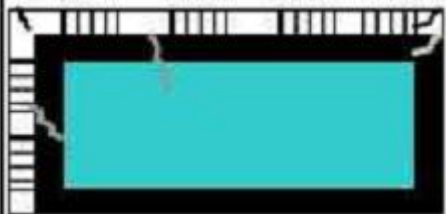
NO.	Defect	Criteria	Remark
1	Dimension(Minor)	By engineering diagram	
2	Cracks(Major)	Extensive crack [Reject]	

#### 10.1.2 LCM appearance defect

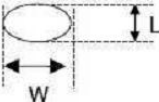
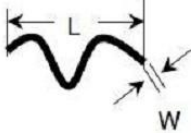
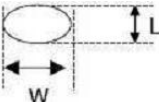
NO.	Defect	Criteria		Remark
		Spec	Permissible Qty	
1	Round type(Minor)	$\phi \leq 0.1\text{mm}$	Disregard	1. $\phi = (W+L)/2$ , L:Length,W=Width 2.Disregard if out of A.A 
		$0.1\text{mm} < \phi \leq 0.2\text{mm}$	2	
		$\phi > 0.2\text{mm}$	0	
2	Line type(Minor)	$W \leq 0.03\text{mm}$	Disregard	1. L:Length,W=Width 2.Disregard if out of A.A 
		$L \leq 3.0\text{mm}$ and $0.03\text{mm} < W \leq 0.05\text{mm}$	2	
		$L \leq 3.0\text{mm}$ and $0.05\text{mm} < W \leq 0.1\text{mm}$	1	
		$W > 0.10\text{mm}$ or $L > 3.0\text{mm}$	0	
3	Polarizer dent(Minor)	$\phi \leq 0.2\text{mm}$	Disregard	1. $\phi = (W+L)/2$ , L:Length,W=Width 2.Disregard if out of A.A 
		$0.2\text{mm} < \phi \leq 0.3\text{mm}$	2	
		$0.3\text{mm} < \phi \leq 0.5\text{mm}$	1	
		$\phi > 0.5\text{mm}$	0	

**10.1.3 FPC**

NO.	Defect	Criteria	Remark
1	Copper peeling(Minor)	Copper peeling [Reject]	
2	Damaged	Damaged[Reject]	

**10.1.4 Black tape**



NO.	Defect	Criteria	Remark
1	Shift(Minor)	IC exposed [Reject]	
2	No black tape(Minor)	No black tape [Reject]	

**10.1.5 Silicon**

NO.	Defect	Criteria	Remark
1	Amount of silicon (Minor)	ITO exposed [Reject]	

**10.1.6 Touch Panel**

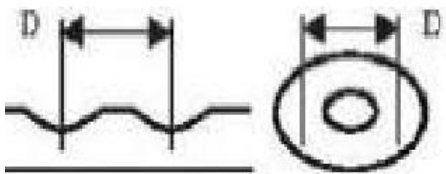
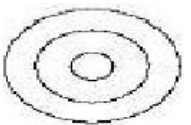
Defect	Criteria	Remark
TP shift	Click on the TP, the distance between the show position and click position>1.5mm [Reject]	

TP Circle, Dent Dot, Bubble MI	Size(mm)	Accessible QTY	
	D ≤ 0.20	Access	
	0.2 < D ≤ 0.3	2	
	0.3 < D ≤ 0.5	1	
	D > 0.5	0	
TP Ripple MI	1.(Figure A): Ripple D>5mm [Reject] 2.(Figure B): Ripple area<1/7 TP area and not impact fonts display effect [Access]		 A   B
Remark: Tear up the protective film to inspect. The distance of two dirt must>10mm; The white dot found in manufacture is conformity to 0.1mm, if >0.1mm [Reject]			

## 10.2 Visual inspection criterion in electrical display

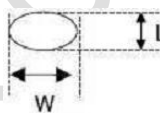
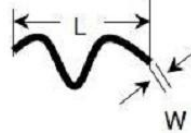
NO.	Defect	Criteria		Remark
		Spec.	Permissible Qty	
1	No display (Major)	Not allowed		
2	Missing line (Major)	Not allowed		
3	Darker or lighter Line (Major)	Not allowed		
4	Weak line(Major)	By limited sample		
5	Bright / Dark point (Minor)	Bright point	1	1:1 sub-pixel: 1R or 1G or 1B 2:Point defect area 1/2 sub pixel.
		Dark point	2	
6	Round type (Minor)	$\phi \leq 0.1\text{mm}$	Disregard	1. $\phi = (W+L)/2$ , L:Length,W=Width 2.Disregard if out of A.A 
		$0.1 < \phi \leq 0.2$	3	
		$\phi > 0.2\text{mm}$	0	
	Line type (Minor)	$W \leq 0.03\text{mm}$	Disregard	1. L:Length,W=Width 2.Disregard if out of A.A 
		$L \leq 3.0\text{mm}$ and $0.03\text{mm} < W \leq 0.05\text{mm}$	2	
		$L \leq 3.0\text{mm}$ and $0.05\text{mm} < W \leq 0.1\text{mm}$	1	
		$W > 0.10\text{mm}$ or $L > 3.0\text{mm}$	0	
	Mura (Minor)	By 5% ND filter invisible		

## 10.3 Others

1. Issues that are not defined in this document shall be discussed and agreed with both parties. (Customer and supplier)
2. Unless otherwise agreed upon in writing, the criteria shall be applied to both parties. (Customer and supplier)

## 11 Suggestions for using LCD modules

### 11.1 Handling of LCM

1. The LCD screen is made of glass. Don't give excessive external shock, or drop from a high place.
2. If the LCD screen is damaged and the liquid crystal leaks out, do not lick and swallow. When the liquid is attach to your hand, skin, cloth etc, wash it off by using soap and water thoroughly and immediately.
3. Don't apply excessive force on the surface of the LCM.
4. If the surface is contaminated, clean it with soft cloth. If the LCM is severely contaminated, use Isopropyl alcohol/Ethyl alcohol to clean. Other solvents may damage the polarizer. The following solvents is especially prohibited: water , ketone Aromatic solvents etc.
5. Exercise care to minimize corrosion of the electrode. Corrosion of the electrodes is accelerated by water droplets, moisture condensation or a current flow in a high-humidity environment.

6. Install the LCD Module by using the mounting holes. When mounting the LCD module make sure it is free of twisting, warping and distortion. In particular, do not forcibly pull or bend the I/O cable or the backlight cable.
7. Don't disassemble the LCM.
8. To prevent destruction of the elements by static electricity, be careful to maintain an optimum work environment.
  - Be sure to ground the body when handling the LCD modules.
  - Tools required for assembling, such as soldering irons, must be properly grounded.
  - To reduce the amount of static electricity generated, do not conduct assembling and other work under dry conditions.
  - The LCD module is coated with a film to protect the display surface. Exercise care when peeling off this protective film since static electricity may be generated.
9. Do not alter, modify or change the the shape of the tab on the metal frame.
10. Do not make extra holes on the printed circuit board, modify its shape or change the positions of components to be attached.
11. Do not damage or modify the pattern writing on the printed circuit board.
12. Absolutely do not modify the zebra rubber strip (conductive rubber) or heat seal connector
13. Except for soldering the interface, do not make any alterations or modifications with a soldering iron.
14. Do not drop, bend or twist LCM.

## 11.2 Storage

1. Store in an ambient temperature of 5 to 45 C, and in a relative humidity of 40% to 60%. Don't expose to sunlight or fluorescent light.
2. Storage in a clean environment, free from dust, active gas, and solvent.
3. Store in antistatic container.

